

Schrauber Bits 1/4" C 6.3**Insert bits 1/4" E 6.3**

Artikel-Nr.	A	L				Preis
3394	PH 1	25				
3395	PH 1	100				
2395	PH 2	25				
2396	PH 2	50				
6332	PH 2	110				

weitere Abmessungen auf Anfrage / further dimensions on request

Schrauber Bits 1/4" E 6.3**Insert bits 1/4" C 6.3**

Artikel-Nr.	A	L	Ø			Preis
7437	PH 2	150	6			
3334	PH 2	89	6			
6369	PH 2	70	6			
2749	PH 2	127	6			

weitere Abmessungen auf Anfrage / further dimensions on request

Schrauber Bits mit Gewinde**Insert bits with thread**

Für Stationäre Schraubeinheiten, z.B. RYKO, Powasert, Striffler, Stürtz, Urban, Wegoma, etc.

For stationary screw units, for ex. RYKO, Powasert, Striffler, Stürtz, Urban, Wegoma, etc.

Artikel-Nr.	A	L	Gewinde	Thread	Ø	Preis
3366	PH 1	45	M5	M5	6	
2394	PH 2	33	M5	M5	6	
5766	PH 2	33	M5	M5	7	
4347	PH 2	45	M5	M5	6	
4362	PH 2 Apex	45	UNF/10-32	UNF/10-32	6	
6112	PH 2	44	M6	M6	8	
6593	PH 2 TIN	45	M5	M5	6	

weitere Abmessungen auf Anfrage / further dimensions on request

Bit-Verlängerungen mit Gewinde**Bit extensions with thread**

Für Stationäre Schraubeinheiten, z.B. RYKO, Powasert, Wegoma, etc.

For stationary screw units, for ex. RYKO, Powasert, Wegoma, etc.

Artikel-Nr.	L	Gewinde	Thread			Preis
4349	175	M5	M5			
4348	175	UNF/10-32	UNF/10-32			

Artikel-Nr. 4349 mit Kombi-Gewinde M5 und UNF/10-32

Artikel-Nr. 4349 with combi-thread M5 and UNF/10-33

weitere Abmessungen auf Anfrage / further dimensions on request

Bit-Verlängerungen mit Gewinde**Bit extensions with thread**

Für Stationäre Schraubeinheiten, 1/4" E 6.3

For stationary screw units, 1/4" E 6.3

Artikel-Nr.	L	Gewinde	Thread	Ø	für / fits for	Preis
6726	158	M5	M5	7		
6725	200	M5	M5	8,4		
5726	116	M5	M5	7	URBAN AMS-600	
4399	157	M5	M5	7	SC1100 & FM3001	
3689	128	M5	M5	7	FAP1000-2000	
6113	167	M6	M6	8,4	KSS612	
6304	130	M6	M6	8,5	Striffler FAT	

weitere Abmessungen auf Anfrage / further dimensions on request**Bit-Verlängerungen mit Gewinde****Bit extensions with thread**

Spezialausführung für AFS, Schirmer, etc.

Special edition for AFS, Schirmer, etc.

Artikel-Nr.	L	Gewinde	Thread	Ø	Bundmutter	Preis
6499	141	M5	M5	8	M8	

weitere Abmessungen auf Anfrage / further dimensions on request**Bit-Verlängerungen mit Gewinde****Bit extensions with thread**

Artikel-Nr.	L _G / L	Gewinde 1	Gewinde 2	Thread 1 / 2	Ø	Preis
3766	108 / 91	M5	M6	M5 / M6		
3767	109 / 91	M5	M5	M5 / M5		
1927	187 / 170	M5	M5	M5 / M5		
1930	188 / 170	M5	M6	M5 / M6		

weitere Abmessungen auf Anfrage / further dimensions on request**Zwischenstück****Connection**

mit beidseitigem Innengewinde

with female thread on both sides

Artikel-Nr.	L	Gewinde	Thread	Ø	Preis
5727	25	M5	M5	8	

weitere Abmessungen auf Anfrage / further dimensions on request

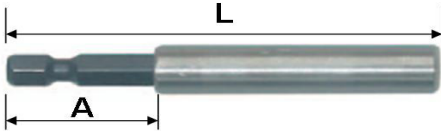
Magnethalter 1/4"						
<i>Socket driver with permanent magnet 1/4"</i>						
						
für Schrauberbits, Einsatz bei Bohrmaschinen, Akkuschauber						
<i>for insert bits, to use in drilling machines</i>						
Artikel-Nr.	L	A				Preis
4360	58	23	1/4"			
weitere Abmessungen auf Anfrage / further dimensions on request						

Sichtflächenmesser

Groove knives

zum Abstechen der Sichtflächenschweißraupe bei Kunststoff-Fenstern, z.B. auf Maschinen von Actual, Pertici, Rotox, Stürtz, Urban, Wegoma, Zierke, etc.

For frooving top and bottom surfaces of welded UPVC-window corners. Used on machines of Actual, Pertici, Rotox, Stürtz, Urban, Wegoma, Zierke, etc.

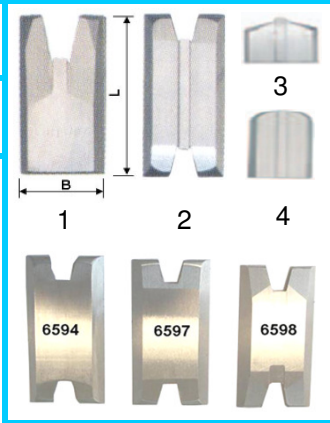

Artikel-Nr.	B	L	N _b	N _t	Bild	Preis
6033	19	35	2,5	0,0	1	
6034	19	35	2,5	0,3	1	
6579	19	35	2,5	0,4	1	
5765	19	35	2,5	0,5	1	
4377	19	35	3,0	0,3	1	
6035	19	35	3,0	0,5	1	
4631	19	40	2,8	0,5	2	
6030	19	40	3,6	0,5	2	
6031	24	41	2,5	0,5	2	
6032	24	41	3,0	0,5	2	
6594	19	40	0,0	0,0	6594	
6597	19	40	0,0R200	0,0	6597	
6598	19	40	0,0	0,05	6598	
3370	24	17	3,0	0,8	3	
6814	19	40	2,8	0,3	4	

weitere Abmessungen auf Anfrage / further dimensions on request

Spannzangen						
Collets						
Passend zu / Suitable to: Elu MOF 77, 131, 177 ROTOX KF-Serie 1 Elumatec Bohreinheiten Elumatec AS 170/GF 171						
						
Artikel-Nr.	A	B	C			Preis
8018	3,0	19,6	34,2			
8019	4,0	19,6	34,2			
8020	5,0	19,6	34,2			
8021	6,0	19,6	34,2			
8022	6,35	19,6	34,2			
8023	7,0	19,6	34,2			
8024	8,0	19,6	34,2			
8025	9,0	19,6	34,2			
8026	9,52	19,6	34,2			
8027	10,0	19,6	34,2			
8028	12,0	19,6	34,2			
8029	12,7	19,6	34,2			
8030	13,0	19,6	34,2			

Spannzangen						
Collets						
Passend zu / Suitable to: Elu MOF 77, 131, 177 ROTOX KF-Serie 1 Elumatec Bohreinheiten Elumatec AS 170/GF 171						
						
Artikel-Nr.	A	B	C			Preis
8031	6,0	13,5	26,0			
8032	6,35	13,5	26,0			
8033	8,0	13,5	26,0			

Spannzangen						
Collets						
Passend zu / Suitable to: Elumatec AS 70, KF 78, Haffner						
Artikel-Nr.	A	B	C			Preis
8034	5,0	70,2	M8			
8035	6,0	70,2	M8			
8036	6,35	70,2	M8			
8037	8,0	70,2	M8			
8038	8,0	69,0	M10	MK 2	Haffner	
8039	9,52	70,2	M8			
8040	10,0	70,2	M8			
8041	10,0	69,0	M10	MK 2	Haffner	

Spannzangen						
Collets						
Passend zu / Suitable to: Elumatec SBZ 610, Haffner, Wegoma KF Typ 311						
Artikel-Nr.	A	B	C			Preis
8042	3,0	16,9	33,0			
8043	4,0	16,9	33,0			
8044	5,0	16,9	33,0			
8045	6,0	16,9	33,0			
8046	6,35	16,9	33,0			
5025	8,00	16,9	33,0			
8048	9,52	16,9	33,0			
6115	10,00	16,9	33,0			
8050	12,0	16,9	33,0			

Spannzangen						
Collets						
Passend zu / Suitable to: Elumatec SBZ 610, Haffner, Wegoma KF						
Artikel-Nr.	A	B	C			Preis
8051	8,0	15,0	30,3			
8052	9,5	15,0	30,3			
8053	10,0	15,0	30,3			

Spannzangen						
Collets						
Passend zu / Suitable to: ROTOX KF ab Serie 2						
Artikel-Nr.	A	B	C			Preis
8054	5,0	15,6	34,5			
8055	6,0	15,6	34,5			
8056	8,0	15,6	34,5			
8057	10,0	15,6	34,5			

Spannzangen						
Collets						
Passend zu / Suitable to: Elumatec SBZ 130 / 150						
Artikel-Nr.	A	B	C			Preis
8058	3,0-4,0	33,0	40,2			
8059	5,0-6,0	33,0	40,2			
8060	7,0-8,0	33,0	40,2			
8061	9,0-10,0	33,0	40,2			
8062	11,0-12,0	33,0	40,2			
8063	15,0-16,0	33,0	40,2			
8064	19,0-20,0	33,0	40,2			

Spannzangen						
Collets						
Passend zu / Suitable to: Pressta-Eissele KF						
Artikel-Nr.	A	B	C			Preis
8065	6,0	20,9	30,9			
8066	8,0	20,9	30,9			
8067	10,0	20,9	30,9			
8068	12,0	20,9	30,9			

Spannzangen						
Collets						
Passend zu / Suitable to: Pressta-Eissele SBZ Type 122, Pressta CopyS						
						
Artikel-Nr.	A	B	C			Preis
8069	0,5-1,0	16,8	28,0			
8070	1,0-1,5	16,8	28,0			
8071	1,5-2,0	16,8	28,0			
8072	2,0-2,5	16,8	28,0			
8073	2,5-3,0	16,8	28,0			
8075	3,0-4,0	16,8	28,0			
8076	4,0-5,0	16,8	28,0			
8077	5,0-6,0	16,8	28,0			
8078	6,0-7,0	16,8	28,0			
8079	7,0-8,0	16,8	28,0			
8080	8,0-9,0	16,8	28,0			
8081	9,0-10,0	16,8	28,0			

Spannzangen						
Collets						
Passend zu / Suitable to: Pressta-Eissele SBZ Type 122, Pressta CopyS						
						
Artikel-Nr.	A	B	C			Preis
8082	3,0-4,0	25,7	34,0			
8083	5,0-6,0	25,7	34,0			
8084	7,0-8,0	25,7	34,0			
8085	9,0-10,0	25,7	34,0			
8086	11,0-12,0	25,7	34,0			

Spannzylinder						
Clamping cylinders						
einfachwirkend, Pneumatikanschluß 1/8" <i>single action, pneumatic connector 1/8"</i> M8 IG / M8 female thread						
Artikel-Nr.	A	B	Hub/Stroke	D		Preis
2973	25	92	50	M6	G1/8"	
1818	40	67	25	M8	G1/8"	
1276	40	87	40	M8	G1/8"	
5022	40	154	80	M8	G1/8"	
4972	40	207	120	M8	G1/8"	
weitere Abmessungen auf Anfrage / further dimensions on request						

Gummipuffer						
Rubber bumper						
passend zu Spannzylindern <i>suitable to pneumatic clamp cylinders</i>						
Artikel-Nr.	A	B	C	Farbe / Colour	Preis	
2965	20	15	M6	schwarz / black		
7082	30	20	M8	schwarz / black		
1742	30	10	M8	weiß / white		
5409	20	15	M6	weiß / white		

Biegeflüssigkeit Spezial						
Bending liquid special						
GLYRY-99-BTK25						
Artikel-Nr.	25 l	50 l	100 l			
4936						

Teflon-Schweißfolie, Rollenware				
Teflon-Welding foil, rolls				
VPE [1 Rolle = 30m²]				
Artikel-Nr.	s x B	Art	Einheit	Preis
2616	0,13x1000mm	selbstklebend	m²	
4848	0,15x1000mm	selbstklebend	m²	
4849	0,13x1000mm	nicht selbstklebend	m²	
2619	0,15x1000mm	nicht selbstklebend	m²	
weitere Abmessungen auf Anfrage / further dimensions on request				

Teflon-Schweißfolie, Zuschnitt					
Teflon-Welding foil					
passend für PVC-Schweißmaschinen-Fabrikate <i>suitable for UPVC-welding machines</i>					
Artikel-Nr.	A	B	Passend zu	Serie	Einheit
a.Anf.	250	390	Urban		per Stück
a.Anf.	250	680	Someco, elumatec	Serie 5	per Stück
a.Anf.	255	425	Urban		per Stück
a.Anf.	340	560	elumatec	700-730	per Stück
a.Anf.	340	680	Someco, elumatec	Serie 5	per Stück
weitere Abmessungen auf Anfrage / further dimensions on request					

Profilleisten / Profile laths

Auflageflächen:



1291-GG20



1292-GW20



6259-FPL20



1304-FP20



2216-BP20S

Artikel-Nr.	Bezeichnung	Marking	Preis
1291	Gleitprofil grün (per m)	Sliding profile green	
1292	Gleitprofil weiß (per m)	Sliding profile white	
6259	Vollfilzprofil (per m)	Full felt profile	
1304	PVC-Filzleiste (per m)	PVC-Filt profile	
2216	Bürstenprofil (per m)	Brush profile	
1293	C-Schiene (per m)	C-Profile	

weitere Abmessungen auf Anfrage / further dimensions on request

Auflageflächen / Surface covers



[1296]



[2176]

Artikel-Nr.	Bezeichnung / Marking	Preis
1305	Filzstreifen selbstklebend / Filt stripes self gluing 20mm	
1295	Filzstreifen selbstklebend / Filt stripes self gluing 30mm	
7436	Filzstreifen selbstklebend / Filt stripes self gluing 50mm	
1294	Noppengummi selbstklebend / Nobbed rubber band self gluing 38mm	
1296	Glasgummi-Hohlkammerprofil / Glas cupped chamber profile 33mm	
1296	Glasgummi-Vollgummiprofil / Glas cupped full profile 33mm	

weitere Abmessungen auf Anfrage / further dimensions on request

Rollenbahn-Anlageflächen / Roller conveyor surface covers



Artikel-Nr.	Bezeichnung / Marking	Ø	Preis
6360	Gummirolle gelb / Rubber roller yellow	48mm	
4608	Gummirolle grau / rubber roller grey	50mm	
6722	Filzrolle melliert braun / Filt roller melliert brown	48mm	
3383	Bürstenrolle / Brush roller	48mm	
1527	Kunststoff-Rolle rot / PVC-Roller red	48mm	

Kreissägeblätter HM-bestückt für ALUCOBOND						
<i>Carbide-tipped saw blades for ALUCOBOND</i>						
<p>Für Plattensägen Holzher/Striebig</p> <p><i>For sheet cutting machines Holzher/Striebig</i></p>						
Artikel-Nr.	A	B	C	Z	Preis	
4764	300	3,2	30	72		
4768	300	3,2	30	96		

Kreissägeblätter HM-bestückt -negativ-						
<i>Carbide-tipped saw blades -negative rake-</i>						
<p>Flach-Trapez-Zahn, geräuschgedämpft für Profile und Vollmaterial aus ALU, PVC und NE-Metallen Für den Einsatz auf Kappsägen / Zugsägen (Sägeblatt von oben)</p> <p>TCG, noise reduced <i>for profiles of aluminium and plastic used on chop-mitre saws</i></p>						
Artikel-Nr.	A	B	C	Z	Preis	
5576	130	2,6	20	36		
5577	138	2,5	20	42		
5578	160	2,5	20	48		
4725	200	1,7	32	80		
3188	200	2,2	32	100		
5579	200	2,5	32	80		
6279	210	2,2	32	100		
2730	210	2,8	32	54		
2737	210	2,8	32	100		
6924	220	2,8	30	65		
4592	230	3,0	30	72		
4719	250	2,2	20	120		
5897	250	2,2	32	120		
5896	250	2,2	32	120		
5342	250	3,0	30	60		

5041	250	3,2	32	80		
4367	250	3,2	32	96		
4103	300	3,2	30	96		
4368	300	3,2	32	96		
4370	300	3,2	40	96		
4485	330	3,2	30	96		
5075	330	3,2	30	102		
5582	350	3,3	32	96		
4371	350	3,4	30	108		
5581	350	3,4	32	108		
5583	350	3,4/2,8	32	108		
5585	350	3,5/2,5	30	108		
1790	400	3,6	30	96		
1785	400	3,6	32	96		
4369	400	3,6	32	120		
4196	400	3,8	30	96		
6336	400	3,8	30	120		
5587	400	3,8	32	96		
4378	400	4,0	30	96		
5588	400	4,0	30	108		
6218	400	4,0	32	96		
5589	400	4,0	32	120		
4486	420	3,8	30	108		
5590	420	4,0	30	96		
6440	420	4,0	30	108		
5407	420	4,0	40	108		
5591	450	4,0	32	108		
3935	450	4,4	30	120		
5541	500	3,7	30	120		
6219	500	4,2	30	100		
4379	500	4,2	30	120		
4372	500	4,4	30	100		
4716	500	4,4	30	120		
3420	550	4,4	40	110		
4591	600	4,6	30	140		
4602	600	4,6	40	140		
* = Industrie Linie						
Artikel-Nr.	A	B	C	Z	NL	Preis
4915	420	4,0/3,2	30	96		
4916*	420	4,0/3,2	30	96	NL 2/10,5/70	
4917*	420	4,0/3,2	40	96		
6440	420	4,0/3,2	30	108		
4918*	420	4,0/3,2	30	108	NL 2/10,5/70	
4919*	420	4,0/3,2	30	120	NL 2/10,5/70	
4920	420	4,0/3,2	40	120		
4921*	450	4,0/3,2	30	108		
4922	450	4,0/3,2	32	108		
4923*	450	4,0/3,2	30	128		
4924	500	4,2/3,6	80	100		
4926*	500	4,2/3,6	30	120	NL 2/10,5/70	
7599*	500	4,2/3,6	30	140	NL 2/10,5/70	
4974*	550	4,4/3,6	30	132	NL 2/10,5/70	
5060*	600	4,6/4,0	30	140		

Kreissägeblätter HM-bestückt -positiv-**Carbide-tipped saw blades -positive rake-****Flach-Trapez-Zahn, geräuschgedämpft**

für Profile und Vollmaterial aus ALU, PVC und NE-Metallen

Für den Einsatz auf Tisch-/Gehrungssägen

(Sägeblatt von unten oder Vorschub von hinten)

TCG, noise reduced

for profiles of aluminium and plastic

used on table-/mitre saws (saw blade feed from the bottom or behind)

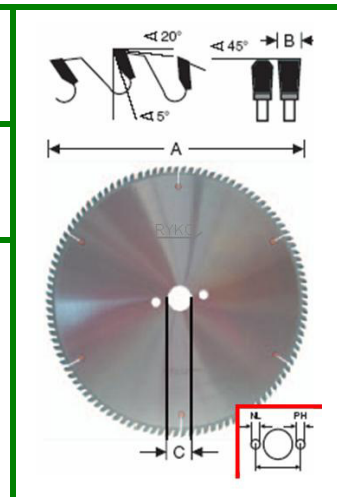

Artikel-Nr.	A	B	C	Z	Peis
4722	175	2,1	20	68	
6085	200	2,1	32	80	
7178	200	2,4	32	64	
4366	250	2,0	30	100	
5580	250	3,2/2,5	32	80	
4726	330	3,2	30	96	
5584	350	3,2	32	108	
5586	350	3,6	32	96	
6335	400	3,8	30	120	
4622	450	4,0	30	108	
5592	500	4,2	30	120	
2706	550	4,4	30	132	
2707	600	4,6	30	140	
6190	700	4,5/3,8	40	192	

* = Industrie Linie ; ** = Industrie Linie speziell Emmegi - Maschinen

Artikel-Nr.	A	B	C	Z	Peis
7571**	400	3,8/3,2	32	96	
7573*	420	4,0/3,2	30	96	
7577**	450	3,8/3,2	32	96	
7585**	500	4,0/3,4	32	120	
7587**	500	5,0/4,0	32	120	
7588*	500	4,2/3,6	30	72	
7589*	500	4,2/3,6	30	120	
7590*	500	4,2/3,6	32	120	
7591**	550	4,0/3,4	32	72	
7592**	550	4,0/3,4	32	96	
7594*	550	4,4/3,6	32	96	
7596*	550	4,4/3,8	30	110	
7597**	550	4,0/3,4	32	126	
7600*	550	4,4/3,6	32	128	
7602*	550	4,4/3,6	80	128	
7598*	600	4,6/4,0	30	140	

Metallkreissägeblätter HSS						
Metall cutting saw blades						
DM05 dampfbehandelt für Stahlbearbeitung Weitere Abmessungen auf Anfrage! DM05 vaporized for steel cutting Other dimensions upon demand!						
Artikel-Nr.	A	B	C	Z	Preis	
4373	200	1,8	32	128		
3598	225	2,0	32	180		
4158	250	2,0	32	160		
4342	250	2,0	32	200		
4119	250	2,0	40	128		
4727	275	2,0	32	220		
4120	275	2,5	32	220		
4118	275	2,5	40	72		
4123	275	2,5	40	120		
2151	275	2,5	40	160		
4126	275	2,5	40	220		
5458	300	2,5	32	220		
5217	315	2,5	32	240		
4728	350	2,5	32	280		
4129	400	3,5	50	80		
4131	450	4,0	40	120		

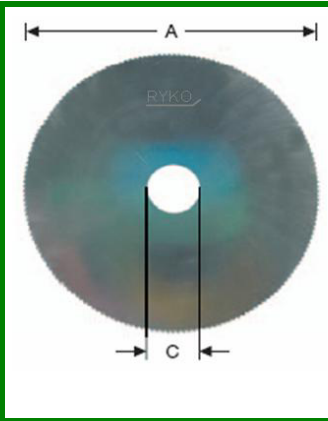
Spezial Sägeblatt HSS						
Special saw blades HSS						
Zum Sägen von Abstandshaltern (Isolierglasfertigung) Weitere Abmessungen auf Anfrage! For cutting spacer-bars (insulating glass manufacturing) Other dimensions upon demand!						
Artikel-Nr.	A	B	C	Z	Preis	
4132	125	1,0	25,4	125		
4133	160	1,0	32	160		

Glasleisten-Sägeblätter**Glazing bead sawblades**

für RYKO, ROTOX, URBAN, Wegoma, Elumatec, ...

1 = HM-bestückt 2 = HSS spezial

for RYKO, ROTOX, URBAN, Wegoma, Elumatec, ...

1 = carbide-tipped 2 = HSS special

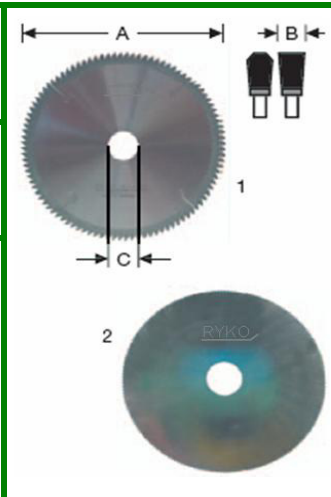

Artikel-Nr.	A	B	C	Z	Abb. / Fig.	Preis
5577	138	2,5	20	42	1	
5578	160	2,5	20	48	1	
4722	175	2,1	20	68	1	
6079	180	2,0	32	180	2	
4138	190	2,1	20	72	1	
4139	200	2,5	32	80	1	
3188	200	2,2	32	100	1	
4333	200	2,0	32	180	2	
2737	210	2,8	32	100	1	
7401	225	2,0	32	100	1	
4719	250	2,2	20	120	1	
4136	250	2,0	20	200	2	
4342	250	2,0	32	200	2	
4137	275	3,2	30	88	1	



Glasleisten-Sägeblätter 45°**Glazing bead sawblades 45°**für **RYKO, ROTOX, URBAN, Wegoma, Elumatec, ...**

1 = HM-bestückt 2 = HSS spezial

R = Rechts L = Links

for **RYKO, ROTOX, URBAN, Wegoma, Elumatec, ...**

1 = carbide-tipped 2 = HSS special

R = Right L = Left

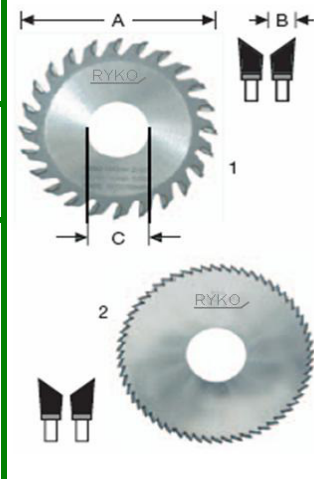

Artikel-Nr.	A	B	C	Z	Abb. [R/L]	Preis
4720	95	2,1	20	20	1 [R]	
4721	95	2,1	20	20	1 [L]	
4723	98	3,0	32	36	1 [R]	
4724	98	3,0	32	36	1 [L]	
3189	103	2,1	32	24	1 [R]	
3190	103	2,1	32	24	1 [L]	
4334	103	2,1	32	60	2 [R]	
4335	103	2,1	32	60	2 [L]	
4143	130	2,5	20	36	1 [R]	
4147	130	2,5	20	36	1 [L]	

Olivenbohrer HSS-E						
Threaded drills HSS-E						
Mit Dachformspitze Aussengewinde rechtslauf Zur Bearbeitung von Kunststoffprofilen mit oder ohne Stahleinlage With taper drills point male thread RH-rotation <i>for working of UPVC profiles with or without filling steel profile</i>						
Artikel-Nr.	A	B	C	D	E	Preis
6047	10	50	---	87	M 10	
3467	10	80	---	113	M 10	
3487	14	80	---	113	M 10	
5028	12	50	---	87	M 10	
3469	12	80	---	113	M 10	
6040	10	45	---	78	M 8 [k/c]	
6041	12	45	---	78	M 8 [k/c]	
6042	14	45	---	77	M 8 [k/c]	
6175	14	50	---	87	M 10 [k/c]	

Olivenbohrer HSS-E						
Threaded drills HSS-E						
Mit Dachformspitze Aussengewinde linkslauf Zur Bearbeitung von Kunststoffprofilen mit oder ohne Stahleinlage With taper drills point male thread LH-rotation <i>for working of UPVC profiles with or without filling steel profile</i>						
Artikel-Nr.	A	B	C	D	E	Preis
5027	10	50	---	87	M 10	
3495	10	80	---	113	M 10	
6177	14	50	---	87	M 10	
3499	14	80	---	113	M 10	
6174	12	50	---	87	M 10	
3497	12	80	---	113	M 10	
6043	10	45	---	78	M 8 [k/c]	
6044	12	45	---	78	M 8 [k/c]	
6045	14	45	---	78	M 8 [k/c]	

Bohrer mit Vorbohrer HSS-E

Threaded drills HSS-E

Mit Vorbohrer

Aussengewinde R/L

Zur Bearbeitung von Kunststoffprofilen mit oder ohne Stahleinlage

With drills point

male thread RH/LH-rotation

for working of UPVC profiles with or without filling steel profile

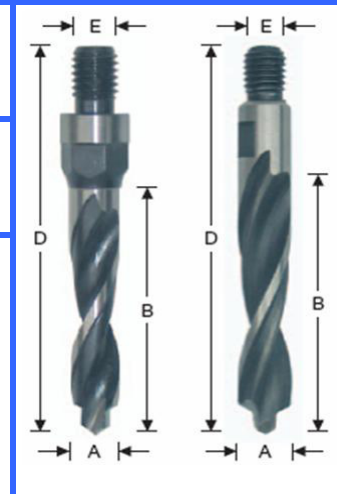

Artikel-Nr.	A	B	C	D	E	Preis
4375	10	50	Rechts/Right	78	M 6 [k/c]	
4376	12	50	Rechts/Right	78	M 6 [k/c]	
3470	14	50	Rechts/Right	78	M 6 [k/c]	
6929	10	50	Links/Left	78	M 8 [k/c]	
6930	10	50	Rechts/Right	78	M 8 [k/c]	
6926	12	50	Links/Left	78	M 8 [k/c]	
6928	12	50	Rechts/Right	78	M 8 [k/c]	
6931	14	50	Links/Left	78	M 8 [k/c]	
6932	14	50	Rechts/Right	78	M 8 [k/c]	
6255	8	50	Links/Left	87	M 10	
6252	8	50	Rechts/Right	87	M 10	
6256	10	50	Links/Left	87	M 10	
6251	10	50	Rechts/Right	84	M 10	
4674	12	50	Rechts/Right	84	M 10	
6257	12	50	Links/Left	87	M 10	
6253	14	50	Rechts/Right	84	M 10	
4675	14	50	Links/Left	87	M 10	
6254	15	50	Rechts/Right	86	M 10	
7606	10	80	Rechts/Right	113	M 10	
7609	10	80	Links/Left	113	M 10	
7607	12	80	Rechts/Right	113	M 10	
7610	12	80	Links/Left	113	M 10	
7608	14	80	Rechts/Right	113	M 10	
7611	14	80	Links/Left	113	M 10	

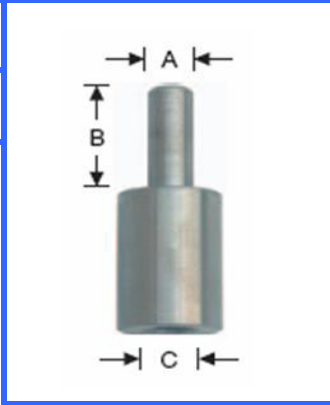
Aufnahme für Bohrer mit Außengewinde					
<i>Plain shank bits</i>					
<p>Zur Verwendung Bohrergruppe (s.o.) in Standard Bohrfutter mit Dachformspitze und Außengewinde M10 rechts/links R = Rechtslauf L = Linkslauf</p> <p><i>for use drill group (s.u.) in standard drills chunk with taper drills point and male screws M10 RH/LH</i> R = RH-rotation L = LH-rotation</p>					
					
Artikel-Nr.	A	B	C		Preis
3500	8	20	M 10	R	
3501	8	20	M 10	L	
3502	8	20	M 10	R	
3503	8	20	M 10	L	
3513	10	20	M 10	R	
3515	10	20	M 10	L	



Einzahnfräser HSSE

Single flute cutters

zum Fräsen und Bohren von Profilen aus Aluminium, Kunststoff und NE-Metallen.

verwendbar auf allen Kopierfräsen, Wasserschlitzzfräsen und Bearbeitungszentren: Schirmer, Elumatec, Emmegi, FOM, Haffner, Kombimatec, MLA, Pertici, Pressta-Eisele, Rapid, Rotox, Striffler, TEKNA, Thorwesten, Urban, Wegoma, ...

Drehzahlbereich ca. 8.000 - 25.000 Umin⁻¹

Ausreichende und Direkte Kühlung bei Aluminiumbearbeitung beachten!

for slotting and drilling in Aluminium- and UPVC-profiles

used on copyrouters, drainage slot routers and CNC-machining-centres: Schirmer, Elumatec, Emmegi, FOM, Haffner, Kombimatec, MLA, Pertici, Pressta-Eisele, Rapid, Rotox, Striffler, TEKNA, Thorwesten, Urban, Wegoma, ...

speed approx 8.000 - 25.000 Umin⁻¹

Adequate and direct cooling-spray is important for aluminium working!

Artikel-Nr.	A	B	C	D	E	Preis
5230	3	12	---	60	8	
5072	4	12	---	60	8	
5093	4	12	---	80	8	
5906	4	40	---	100	8	
3599	5	12	---	60	6	
5076	5	12	---	60	8	
5094	5	14	---	60	8	
5074	5	14	---	80	8	
5088	5	18	---	60	8	
5092	5	25	---	70	8	
5909	5	35	---	80	8	
5908	5	25	---	100	8	
4803	5	14	---	100	8	
4943	5	14	---	120	8	
5095	5	18	---	120	8	
5085	5	20	---	60	5	
5078	5	20	---	80	8	
5907	5	20	---	100	8	
5073	5	35	---	100	8	
5084	5	40	---	80	8	
4188	5	40	---	100	8	
5511	5	40	---	120	8	
4953	5	45	---	100	8	
5912	6	14	---	60	8	
3619	6	14	---	60	6	
5915	6	25	---	70	8	
5820	6	14	---	80	8	
5914	6	20	---	80	8	
5913	6	14	---	100	8	
5917	7	14	---	60	8	
5918	7	14	---	80	8	
4374	8	14	---	80	8	
5919	8	25	---	80	8	
5500	8	14	---	100	8	
5920	8	25	---	100	8	
5512	8	14	---	120	8	

5513	8	18	---	100	8	
5089	8	25	---	120	8	
5921	8	40	---	100	8	
5922	9	14	---	80	8	
5080	10	14	---	80	8	
5081	10	14	---	100	8	
5090	10	14	---	120	8	
3620	10	22	---	100	8	
5923	10	14	---	80	10	
3631	10	25	---	90	10	
5514	10	14	---	120	10	
3632	11	14	---	80	8	
5082	12	14	---	80	8	
3660	12	28	---	100	8	
5086	12	14	---	80	10	
5096	12	14	---	100	10	

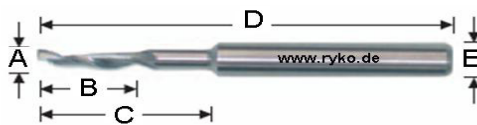

Einzahnfräser HSS-E
Hals freigeschliffen

Single flute cutters
stepped shank

zum Fräsen und Bohren von Profilen aus Aluminium, Kunststoff und NE-Metallen.

verwendbar auf allen Kopierfräsen, Wasserschlitzfräsen und Bearbeitungszentren: Schirmer, Elumatec, Emmegi, FOM, Haffner, Kombimatec, MLA, Pertici, Pressta-Eisele, Rapid, Rotox, Striffler, TEKNA, Thorwesten, Urban, Wegoma, ...

Drehzahlbereich ca. 8.000 - 25.000 Umin⁻¹

Ausreichende und Direkte Kühlung bei Aluminiumbearbeitung beachten!

for slotting and drilling in Aluminium- and UPVC-profiles

used on copyrouters, drainage slot routers and CNC-machining-centres: Schirmer, Elumatec, Emmegi, FOM, Haffner, Kombimatec, MLA, Pertici, Pressta-Eisele, Rapid, Rotox, Striffler, TEKNA, Thorwesten, Urban, Wegoma, ...

speed approx 8.000 - 25.000 Umin⁻¹

Adequate and direct cooling-spray is important for aluminium working!

Artikel-Nr.	A	B	C	D	E	Preis
5929	4	16	45	90	8	
5930	5	14	35	80	8	
3675	5	18	35	80	6	
4187	5	18	35	80	8	
4487	5	16	45	90	8	
3717	5	16	55	90	8	
5934	5	18	35	100	8	
5937	5	25	55	100	8	
6114	5	18	35	120	8	
5931	5	14	75	120	8	
5935	5	20	45	90	8	
5936	5	20	45	100	8	
3719	5	14	65	125	8	
5938	6	14	35	80	8	
5939	6	16	45	90	6	
3720	6	18	35	100	8	
5940	7	14	45	80	8	
5941	8	14	54	80	8	

5943	8	14	68	100	8	
5945	8	30	70	100	8	
5944	8	14	90	120	8	
3746	8	30	70	120	8	
5946	10	14	65	85	10	
3747	10	25	45	90	10	
5947	10	14	75	96	10	
5949	10	30	70	100	10	
5948	10	14	95	120	10	
3748	10	30	70	120	10	

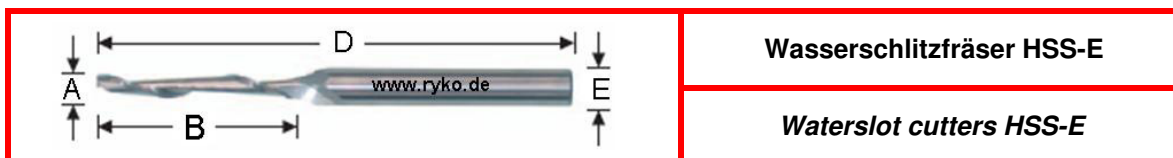

Wasserschlitzzfräser HSS-E

Waterslot cutters HSS-E

zum Fräsen von Wasserschlitzen in Aluminium und PVC.

verwendbar auf allen Wasserschlitzzfräsen von: Elumatec, Haffner, Kombimatec, MLA, Pertici, Rotox, Urban, Wegoma, ...

Einschneidig spiralig

for waterslots / drainage for Aluminium- and UPVC-profiles

used on waterslot routing machines: Elumatec, Haffner, Kombimatec, MLA, Pertici, Rotox, Urban, Wegoma, ...

Single flute spiral

Artikel-Nr.	A	B	C	D	E	Preis
7613	4	40	---	100	8	
7614	4	20	---	120	8	
7615	5	35	---	80	8	
7616	5	35	---	90	8	
7617	5	20	---	100	8	
7618	5	25	---	100	8	
7619	5	30	---	100	8	
7620	5	40	---	100	8	
7621	5	45	---	100	8	
7622	5	40	---	120	8	
7623	6	40	---	100	8	
7624	8	40	---	80	8	
7625	8	40	---	100	8	
7625	8	40	---	120	8	

		Einzahnfräser HSS-E Single flute cutters HSS-E				
TIN - beschichtet für längere Standzeit bei der PVC Bearbeitung TIN - coated for longer durability in UPVC profiles						
Artikel-Nr.	A	B	C	D	E	Preis
7627	4	12	---	60	8	
7628	5	12	---	60	8	
7629	5	18	---	60	8	
7630	5	18	35	80	8	
7631	5	16	45	90	8	
7632	5	25	---	100	8	
7633	5	40	---	100	8	
7634	6	14	---	60	8	
7635	8	14	---	80	8	
7636	8	14	54	80	8	
7637	8	14	---	120	8	

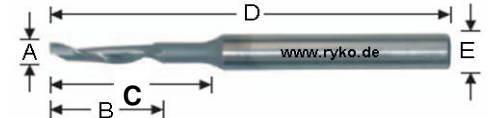
		Einzahnfräser HSS-E Single flute cutters HSS-E				
CrN - beschichtet für längere Standzeit bei der PVC- und Aluminium Bearbeitung CrN - coated for longer durability in UPVC- and Aluminium profiles						
Artikel-Nr.	A	B	C	D	E	Preis
7639	4	12	---	60	8	
7640	5	12	---	60	8	
7641	5	18	---	60	8	
7642	5	18	35	80	8	
7643	5	35	---	80	8	
7644	6	14	---	60	8	
7645	7	14	---	60	8	
7646	8	14	---	80	8	
7647	8	14	54	80	8	

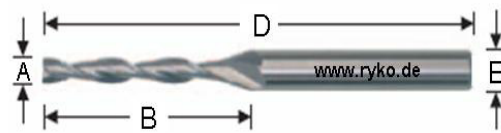

Wasserschlitzzfräser HSS-E

*Waterslot cutters HSS-E***zum Fräsen von Wasserschlitzen in Aluminium.**

verwendbar auf allen Wasserschlitzzfräsen von: Elumatec, Haffner, Kombimatec, MLA, Pertici, Rotox, Urban, Wegoma, ...

Zweischneidig spiralgig

for waterslots / drainage for Aluminium profiles

used on waterslot routing machines: Elumatec, Haffner, Kombimatec, MLA, Pertici, Rotox, Urban, Wegoma, ...

Double flute spiral

Artikel-Nr.	A	B	C	D	E	Preis
7648	5	30	---	90	8	
7649	5	40	---	100	8	

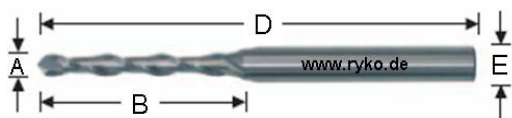

Wasserschlitzzfräser HSS-E

*Waterslot cutters HSS-E***zum Fräsen von Wasserschlitzen in PVC.**

Zweischneidig, spiralgig mit Bohrspitze

for waterslots / drainage for UPVC profiles

Double flute spiral with drills point

Artikel-Nr.	A	B	C	D	E	Preis
7650	5	45	---	100	8	
7651	5	30	---	90	8	
7652	5	40	---	90	8	
7653	5	40	---	100	8	

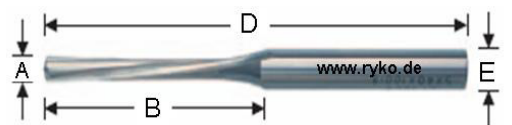

Bohrnutenfräser HSS-E

*Milling cutters HSS-E***für Alu- und PVC-Profilbearbeitung. Specialausführung für höchste Beanspruchung**

Zweischneidig, spiralgig mit leichtem Drall

for Aluminium and UPVC routing and waterslotting. Specially designed to give added

Double flute spiral with small twist

Artikel-Nr.	A	B	C	D	E	Preis
7654	4	40	---	100	8	
7655	5	35	---	80	8	
7656	5	40	---	100	8	
7657	5	45	---	120	8	
7658	6	40	---	100	8	

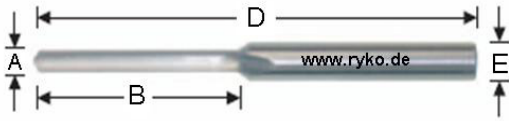
				Wasserschlitzzfräser HSS-E		
				Waterslot cutters HSS-E		
zum Fräsen von Wasserschlitzen in PVC. Einschneidig, gerade mit Bohrspitze for waterslots / drainage for UPVC profiles. Single flute straight with drills point						
Artikel-Nr.	A	B	C	D	E	Preis
5951	4	25	---	100	8	
5953	5	30	---	70	8	
5955	5	35	---	80	8	
5957	5	35	---	120	8	
5958	5	45	---	90	8	
5956	5	35	---	70	8	
5959	5	45	---	100	8	
5961	5	55	---	100	8	
5962	5	55	---	120	8	
5960	5	45	---	120	8	
5963	5	65	---	100	8	
5964	6	30	---	100	8	
5965	6	35	---	120	8	
5966	6	45	---	100	8	
5967	6	45	---	120	8	
5969	6	55	---	120	8	
5970	8	30	---	100	8	

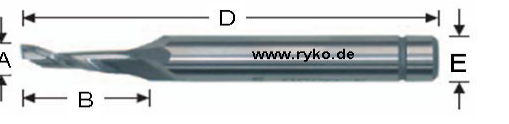
				Einzahnfräser HSS-E		
				Single flute cutters HSS-E		
Spezialausführung für Stahlprofile verwendbar auf allen Kopierfräsen und Bearbeitungszentren: Elumatec, Emmegi, Haffner, MLA, Pertici, Pressta-Eisele, Rapid, Rotox, Striffler, TEKNA, Wegoma, ... Drehzahlbereich ca. 6.000 - 12.000 Umin ⁻¹ Ausreichende und Direkte Kühlung ist zu beachten! Special cutters for steel cutting used on copyrouters and CNC-machining-centres: Elumatec, Emmegi, Haffner, MLA, Pertici, Pressta-Eisele, Rapid, Rotox, Striffler, TEKNA, Wegoma, ... speed approx 6.000 - 12.000 Umin ⁻¹ Adequate and direct cooling-spray is important!						
Artikel-Nr.	A	B	C	D	E	Preis
5927	5	12	---	60	8	
5928	8	14	---	80	8	

**Doppelfräser VHM**

**Double ended single flute cutters
-solide carbide-**

**Spezialausführung für Stahlprofile
Einschneidig, spiralig**

verwendbar auf allen Kopierfräsen und Bearbeitungszentren: Elumatec, Emmegi, Haffner, MLA, Pertici, Pressta-Eisele, Rapid, Rotox, Striffler, TEKNA, Wegoma, ...

Drehzahlbereich ca. 6.000 - 12.000 Umin⁻¹

Ausreichende und Direkte Kühlung ist zu beachten!

Zur Bearbeitung von Stahlprofilen auf Kopierfräsmaschinen

**Special cutters for steel cutting
Single flute, spiral**

used on copyrouters and CNC-machining-centres: Elumatec, Emmegi, Haffner, MLA, Pertici, Pressta-Eisele, Rapid, Rotox, Striffler, TEKNA, Wegoma, ...

speed approx 6.000 - 12.000 Umin⁻¹

Adequate and direct cooling-spray is important!

For working steel profiles on copy routers.

Artikel-Nr.	A	B	C	D	E	Preis
5973	5	12	---	65	8	

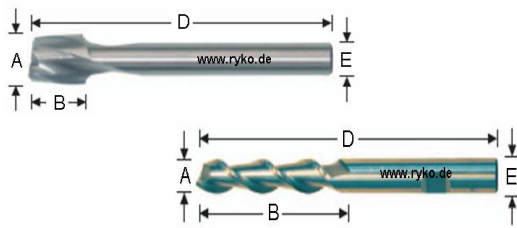

Bohrnutenfräser HSS-E

Milling cutters HSS-E

mit spezial Stirnanschliff für leichtes Eintauchen

Zweischneidig, spiralig

Zur Bearbeitung von Profilen aus PVC und Aluminium

Special grinded for easy drilling

double flutes, spiral

For working UPVC and Aluminium profiles

Artikel-Nr.	A	B	C	D	E	Preis
6901	4	12	---	60	8	
7659	5	12	---	60	8	
7600	6	14	---	60	8	
7661	7	14	---	60	8	
7662	8	14	---	80	8	
7663	8	38	---	88	8	
7664	8	30	---	100	8	
7665	8	40	---	100	8	
7666	8	38	---	88	10	
7667	10	14	---	80	8	
7668	10	45	---	95	10	
7669	10	25	---	120	10	
7670	12	14	---	80	8	
7671	12	35	---	90	12	
7672	12	30	---	100	12	
7673	12	53	---	110	12	
7674	13	26	---	73	12	
7675	14	35	---	90	12	
7676	14	53	---	110	12	
7677	14	30	---	100	14	
7678	16	35	---	90	12	
7679	16	63	---	123	16	
7680	18	35	---	90	12	
7681	18	63	---	123	16	
7682	20	35	---	90	12	
7683	20	75	---	141	20	
7684	22	32	---	80	12	

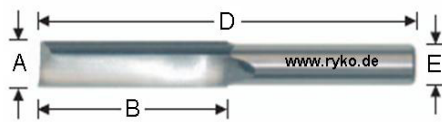
**Bohrnutenfräser HSS-E****Milling cutters HSS-E****Zweischneidig, gerade genutet**

für PVC-Profilbearbeitung auf Kopierfräsen (z.B. Schlosskasten)

Double flutes, straight

for UPVC working. Used on copy routers

Artikel-Nr.	A	B	C	D	E	Preis
7685	5	27	---	80	8	
7686	5	35	---	100	8	
7687	6	30	---	100	8	
7688	7	30	---	100	8	
7689	8	15	---	90	8	
7690	8	30	---	100	8	
7691	8	30	---	70	10	
7692	10	40	---	75	8	
7693	10	40	---	97	10	
7694	10	50	---	100	10	
7695	10	25	---	120	10	
7696	12	40	---	75	8	
7697	12	40	---	75	10	
7698	12	48	---	97	10	
7699	14	48	---	97	10	
7701	16	48	---	97	10	
7702	18	48	---	97	10	
7703	10	40	HM-best. Carb.tip.	97	10	
7704	12	40	HM-best. Carb.tip.	97	10	
7705	14	40	HM-best. Carb.tip.	97	10	
7706	16	30	HM-best. Carb.tip.	90	8	
7707	16	45	HM-best. Carb.tip.	97	10	

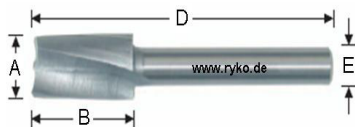
**Schlosskastenfräser HSS-E****Slot Milling cutters HSS-E****Zweischneidig, spiralg**

für PVC-Profilbearbeitung

Double flutes, spiral

for UPVC working

Artikel-Nr.	A	B	C	D	E	Preis
4148	12	25	---	75	8	
4149	12	25	---	85	8	
4150	14	25	---	75	8	

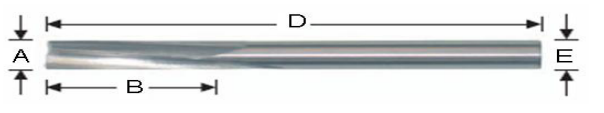
		Langlochfräser HSS-E				
		Slot mortise cutters HSS-E				
Zweischneidig, leicht spiralig, zylindrisch durchgehender Schaft Für höchste Ansprüche in PVC und Holz (z.B. Schlosskasten)						
Two flutes, slow spiral, cylindric shank For heavy work in UPVC and wood						
Artikel-Nr.	A	B	C	D	E	Preis
7708	6	25	---	70	9	
7709	7	35	---	8	7	
7710	8	35	---	80	8	
7711	10	40	---	90	10	
7712	12	45	---	100	12	

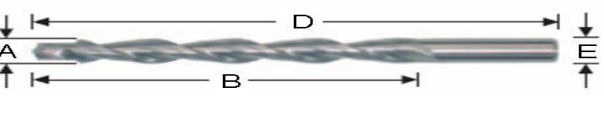
		Fräsbohrer HSS-E				
		Routing drills HSS-E				
passend zu elumatec KF 78/60 <i>fits for elumatec KF 78/60</i>						
Artikel-Nr.	A	B	C	D	E	Preis
7713	10	90	---	148	10	
7715	10	72	---	126	10	

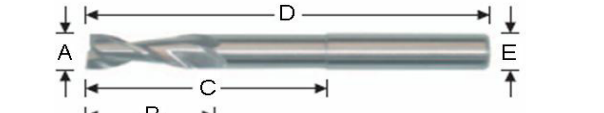
		Schaftfräser HSS-E				
		Routing drills HSS-E				
passend zu elumatec KF 178, zweischneidig, spiralig R = Rechts-Lauf - L = Links-Lauf <i>fits for elumatec KF 178, two flutes, spiral</i> R = Right-Rotation - L = Left-Rotation						
Artikel-Nr.	A	B	C	D	E / [R/L]	Preis
7716	10	22	60	100	10 [R]	
7717	10	22	40	100	10 [L]	
7718	10	22	70	120	10 [R]	

		Stufenfräser HSS-E Stepped cutters HSS-E				
für ROTOX-Kopierfräsen R = Rechts-Lauf - L = Links-Lauf for ROTOX-copy routers R = Right-Rotation - L = Left-Rotation						
Artikel-Nr.	a	A	D	E	Lauf	Preis
7719	10,5	17,5	75	10	R	
7720	10,5	17,5	75	10	L	
7721	10,5	17,5	95	10	R	
7722	10,5	17,5	95	10	L	

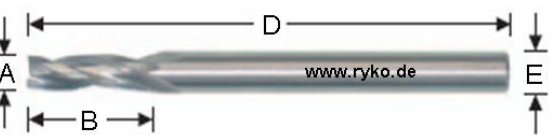
		Innenfalz-/Dichtungsnutfräser HSS-E Router / gasket groove cutters HSS-E				
für Schweißraupen-Verputzmaschinen z.B. elumatec, Stürtz, Urban, Wegoma, ... Vollhartmetall sowie TIN-Beschichtung auf Anfrage for corner-cleaning machines f.ex. Elumatec, stürtz, Urban, Wegoma, ... Solid-carbide and TIN-coating on demand						
Artikel-Nr.	a	A	D	E	Z/T	Preis
7723	5	24	68	6	2	
7724	6	24	68	6	2	
7725	6	20	120	8	2	
7726	6	20	120	8	3	
7727	6,5	16	55	6	2	
7728	6,5	16	66	6	2	
7729	6,5	16	75	6	2	
7730	7	16	66	6	2	
7731	7	16	68	6	3	
7732	7	20	100	8	2	
7733	7	20	100	8	3	
7734	7	20	120	8	2	
7735	7	20	120	8	3	
7736	7,5	16	55	6	2	
7737	7,5	16	66	6	2	
7738	7,5	16	75	6	2	
7739	8	20	100	8	3	
7740	8	20	120	8	2	
7741	8	20	120	8	3	
7742	10	20	120	8	2	
7743	10	20	120	8	3	
7744	12	12	120	8	2	
7745	12	12	120	8	3	
7746	14	12	120	8	2	
7747	14	12	120	8	3	

	Bohrnutenfräser HSS-E					
	Slot milling cutters HSS-E					
für Bearbeitungszentren von: Elumatec, Stürtz, Thorwesten, Wegoma,... for CNC machines from: Elumatec, Stürtz, Thorwesten, Wegoma,...						
Artikel-Nr.	A	B	D	E	Z/T [P]	Preis
7748	10	45	95	10	4 [2]	
7749	12	53	110	12	4 [2]	
7750	12	53	110	12	3 [2]	
7751	13	53	110	12	4 [2]	
7752	12	53	110	12	4 [1]	
7753	12	53	110	12	3 [1]	
7754	12	53	110	12	4 [3]	

	Einzahnfräser VHM-HSC Ausführung					
	Single flute cutters -solide carbide-					
Spezialausführung für höchste Ansprüche und Schneidleistung auf Bearbeitungszentren <i>Highspeed version special designed for highest pretentions used on CNC-machines</i>						
Artikel-Nr.	A	B	C	D	E	Preis
7755	8	27	---	80	8	
7756	8	32	50	80	8	
7757	10	52	---	100	10	
VHM-Einzahnfräser für höchste Ansprüche bei Aluminium- und PVC-Bearbeitung Solide carbide single flute cutters for highest pretentions in aluminium and PVC						

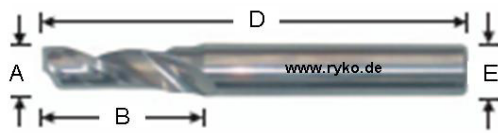

Einzahnfräser VHM

Single flute cutters -solide carbide-

zum Fräsen und Bohren von Profilen aus Aluminium, Kunststoff und NE-Metallen

verwendbar auf allen BAZ: Elumatec, Emmegi, Haffner, MLA, Pertici, Rapid, Rotox, ...

Drehzahlbereich ca. 8.000 - 30.000 UpM

Ausreichende und Direkte Kühlung bei Aluminiumbearbeitung beachten!

for slotting and drilling Aluminium- and UPVC-profiles

used on CNC-machining centres: Elumatec, Emmegi, Haffner, MLA, Pertici, Rapid, Rotox, ...

Adequate and direct cooling-spray is important for aluminium working!

Artikel-Nr.	A	B	C	D	E	Preis
7758	2	10	---	50	6	
5974	3	12	---	60	6	
7759	3	12	---	60	8	
7760	3,2	12	---	70	6	
7761	4	12	---	70	4	
5975	4	15	---	60	6	
7762	4	14	---	60	6	
7763	4	8	---	70	6	
7764	4	12	---	70	6	
7765	4	20	---	60	8	
7766	5	20	---	60	5	
7767	5	12	---	70	5	
5976	5	25	---	60	5	
7768	5	30	---	70	5	
7769	5	40	---	80	5	
7770	5	45	---	80	5	
7771	5	30	---	90	5	
7772	5	16	---	60	6	
7773	5	40	---	80	6	
7774	5	20	---	60	8	
7775	5	15	---	70	8	
7776	5	30	---	70	8	
7777	5	20	---	80	8	
7778	5	30	---	80	8	
7779	5	40	---	80	8	
7780	5	20	---	90	8	
7781	5	30	---	90	8	
7782	5	12	---	100	8	
7783	5	20	---	100	8	
7784	5	40	---	100	8	
7785	6	16	---	60	6	
5977	6	20	---	60	6	
7786	6	12	---	70	6	
7787	6	30	---	80	6	
7788	6	40	---	80	6	
7789	6	12	---	100	6	
7790	6	30	---	110	6	
7791	7	18	---	60	6	
7792	8	18	---	60	8	
7793	8	12	---	70	8	
5978	8	25	---	75	8	
7794	8	35	---	90	8	
7795	8	16	---	100	8	
7796	8	14	---	120	8	

7797	8	35	---	120	8	
7798	10	22	---	70	10	
5979	10	22	---	75	10	
7799	10	40	---	97	10	
7800	10	30	---	100	10	
7801	12	35	---	83	10	
7802	12	45	---	80	12	
7803	12	24	---	70	12	
5980	12	32	---	80	12	
7804	12	42	---	80	12	
7805	12	35	---	100	12	
7806	14	35	---	83	10	
7807	14	26	---	75	14	
7808	16	25	---	90	16	
7809	20	30	---	100	26	

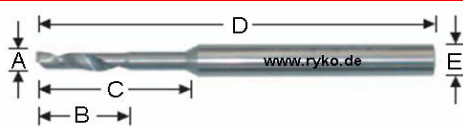

**Einzahnfräser VHM
-Hals freigeschliffen-**

**Single flute cutters -solide carbide-
stepped shank**

zum Fräsen und Bohren von Profilen aus Aluminium, Kunststoff und NE-Metallen

verwendbar auf allen BAZ: Elumatec, Emmegi, Haffner, MLA, Pertici, Rapid, Rotox, ...

Drehzahlbereich ca. 8.000 - 30.000 UpM

Ausreichende und Direkte Kühlung bei Aluminiumbearbeitung beachten!

Schüco = *

for slotting and drilling Aluminium- and UPVC-profiles

used on CNC-machining centres: Elumatec, Emmegi, Haffner, MLA, Pertici, Rapid, Rotox, ...

Adequate and direct cooling-spray is important for aluminium working!

Artikel-Nr.	A	B	C	D	E	Preis
7810	3,2	12	40	70	4	
7811	4	15	35	80	8	
7812*	5	8	40	77	6	
7813	5	16	35	80	8	
7814	5	20	45	90	8	
7815	5	35	55	90	8	
7816	5	30	50	100	8	
7817	5	40	50	100	8	
7818	5	30	60	100	8	
7819*	6	10	40	77	6	
7820	6	20	35	80	8	
7821	6	20	30	90	8	
7822	7	18	45	70	8	
7823	8	16	40	70	8	
7824*	8	10	40	80	8	
7825	8	16	70	100	8	
7826*	10	15	65	110	10	
7827	10	20	70	100	10	
7828	12	20	70	100	12	
7829	16	30	50	100	16	

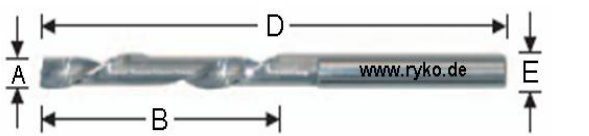
				Einzahnfräser VHM		
				Single flute cutters -solide carbide-		
Spezialausführung Linksdrall Spanauswurf nach unten Special version <i>RH/cut - LH/spiral</i> <i>downward chip clearance</i>						
Artikel-Nr.	A	B	C	D	E	Preis
7830	3	10	---	60	3	
7831	4	14	---	60	4	
7832	5	20	---	60	5	
7833	5	25	---	60	5	
7834	5	40	---	80	5	
7835	5	50	---	80	5	
7836	5	70	---	100	5	
7837	6	20	---	60	6	
7838	8	20	---	60	8	
7839	8	40	---	90	8	
7840	10	30	---	75	10	
7841	12	30	---	75	12	
7842	14	25	---	75	14	
7843	16	25	---	90	16	
7844	20	30	---	100	20	

				Wasserschlitzzfräser VHM		
				Waterslot cutters -solide carbide-		
Einschneidig, Bohrspitze, flacher Drallwinkel Spezialausführung für CNC-Maschinen (z.B. Supercut, etc.) Single-flute, drills point, flat twist angle <i>special version for CNC-Machines (f.ex. Supecut, etc.)</i>						
Artikel-Nr.	A	B	C	D	E	Preis
7845	5	25	---	60	5	
7846	5	40	---	80	5	

		Wasserschlitzfräser VHM Waterslot cutters -solide carbide-				
Einschneidig, spiralig Spezialausführung - für CNC-Maschinen - mit Bohrspitze 90° für Bearbeitungszentren von elumatec, Haffner, Handtmann, HEFI, Rapid, Schirmer, Stürtz, etc. Single flute, spiral <i>special version for CNC-machines - with drill point 90°</i> <i>for machining-centres as elumatec, Haffner, Handtmann, HEFI, Rapid, Schirmer, Stürtz, etc.</i>						
Artikel-Nr.	A	B	C	D	E	Preis
7847	5	40	---	80	5	
7848	5	20	---	60	8	
7849	5	30	---	80	8	
7850	5	40	---	80	8	
7851	5	35	55	90	8	
7852	5	35	55	100	8	
7853	6	40	---	80	6	
7854	6	35	72	110	8	

		Wasserschlitzfräser VHM Waterslot cutters -solide carbide-				
Einschneidig, spiralig VHM-Schneide in Stahlschaft 8mm Zur PVC Bearbeitung Single flute, spiral <i>Solide carbide cutting edge with steel shank 8mm</i> <i>For UPVC working</i>						
Artikel-Nr.	A	B	C	D	E	Preis
7855	5	20	35	60	8	
7856	5	20	35	80	8	
7857	5	20	45	90	8	
7858	5	40	50	90	8	
7859	5	40	50	100	8	
7860	5	45	60	120	8	

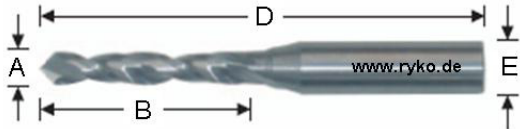
		Wasserschlitzfräser VHM Waterslot cutters -solide carbide-				
Zweischneidig, mit Bohrspitze 90° für Bearbeitungszentren von elumatec, Haffner, Handtmann, HEFI, Rapid, Schirmer, Stürtz, etc. Two flutes, with drills point 90° for machining-centres as elumatec, Haffner, Handtmann, HEFI, Rapid, Schirmer, Stürtz, etc.						
Artikel-Nr.	A	B	C	D	E	Preis
7861	5	40	---	80	5	
7862	5	40	---	100	5	
7863	5	20	---	60	8	
7864	5	30	---	70	8	
7865	5	40	---	80	8	
7866	5	20	---	85	8	
7867	5	30	---	90	8	
7868	5	40	---	100	8	
7869	5	45	---	100	8	
7870	6	40	---	75	8	
7871	6	40	---	95	8	
7872	6	30	---	90	8	
7873	6	45	---	90	8	
7874	8	65	---	100	8	

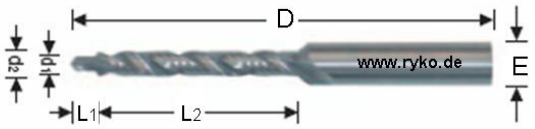
		Stufenfräser VHM Stepped cutters -solide carbide-				
Zweischneidig für Bearbeitungszentren von elumatec, Haffner, Rapid, Stürtz, etc. Two flutes for machining-centres as elumatec, Haffner, Rapid, Stürtz, etc.						
Artikel-Nr.	d1	L1	d2	L2	D	E
7875	2	4,5	5	20	60	8
7876	2,5	4,5	5	20	60	8
7877	2,5	4,5	5	30	70	8
7878	3	4,5	5	20	60	8
7879	3	4,5	5	30	70	8
7880	3	5,5	5	30	70	8
7881	3	4,5	5	40	80	8
7882	4	10	5	40	80	8
7883	4	20	8	57	100	8

		Innenfalzfräser VHM Gasket groove cutters -solide carbide-				
Stirn Kegelform für Verputzautomaten URBAN, etc. Front cone-shaped for corner cleaners as URBAN, etc.						
Artikel-Nr.	A	B	C	D	E	Preis
7884	6	20	5	100	8	
7885	8	20	5	100	8	

		Wasserschlitzzfräser VHM Waterslot cutters -solide carbide-				
Einschneidig, spiralig VHM-Schneide in Stahlschaft 8mm für BAZ AFS-Schirmer P1 = Rechtslauf / Rechtsdrall P2 = Linkslauf / Linksdrall Single flute, spiral solid carbide, cutting edge with steel shank 8mm for CNC-Machining Center AFS Schirmer P1 = RH cut / RH spiral P2 = LH cut / LH spiral						
Artikel-Nr.	A	B / C	D	E	P	Preis
7886	2,7/5	30	80	8	1	
7887	2,7/5	30 / 50	100	8	1	
7888	5	25	80	8	1	
7889	5	30 / 50	100	8	1	
7892	2,7/5	30	80	8	2	
7893	2,7/5	30 / 50	100	8	2	
7890	5	25	80	8	2	
7891	5	30 / 50	100	8	2	

		Schafffräser VHM Milling cutters -solide carbide-				
Für Stahlbearbeitung mit Spezialbeschichtung, Zweischneidig, spiralig verwendbar auf Kopierfräsen und Bearbeitungszentren For steel working-special coated, Twoflutes, spiral for copy routers and high speed router machines						
Artikel-Nr.	A	B	C	D	E	Preis
7894	5	10	---	57	6	
7895	6	10	---	57	6	
7896	8	16	---	63	8	
7897	10	19	---	72	10	

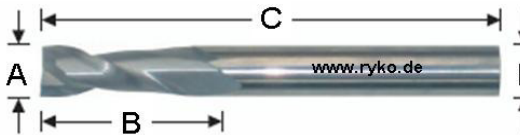
				Bohrnutenfräser VHM		
				Milling cutters -solide carbide-		
Für Stahlbearbeitung mit Spezialbeschichtung, Zweischneidig, spiralg verwendbar auf Kopierfräsen und Bearbeitungszentren						
For steel working-special coated, Twoflutes, spiral for copy routers and high speed router machines						
Artikel-Nr.	A	B	C	D	E	Preis
7898	3	8	58	---	6	
7899	5	30	70	---	5	
7913	6	40	100	---	6	
7914	8	18	60	---	8	
7915	8	35	80	---	8	
7916	8	40	10	---	8	
7917	8	70	150	---	8	
7918	10	40	100	---	10	
7919	10	70	150	---	10	
7920	12	22	70	---	12	
7921	12	45	100	---	12	
7922	14	45	100	---	14	
7923	16	45	100	---	16	
7924	16	20	115	60	16	

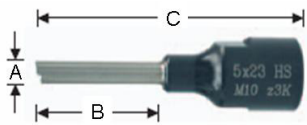
				Nutfräser HSS -Innengewinde M10-		
				Milling cutters HSS -female thread M10-		
Zur Bearbeitung von PVC-Profilen mit Handmaschinen z.B. ROTOX, Striffler, Strima, etc.						
For working UPVC-profiles with hand-routers f. ex. ROTOX, Striffler, Strima, etc.						
Artikel-Nr.	A	B	C			Preis
3516	3	8	52			
4834	4	10	35			
4553	4	12	52			
4649	5	10	35			
4554	5	23	52			
3517	6	23	52			
4650	8	26	47			
4642	10	23	43			
3518	10	30	50			
4636	11	17	50			
4639	12	14,5	43			
4711	12	23	43			
4744	12	38	58			
4644	14	21	43			
4645	16	23	43			
5395	18	23	43			
3598	12	14,5	43	HM	Carb.-tip.	
7938	12	45	80	M12	Thread M12	

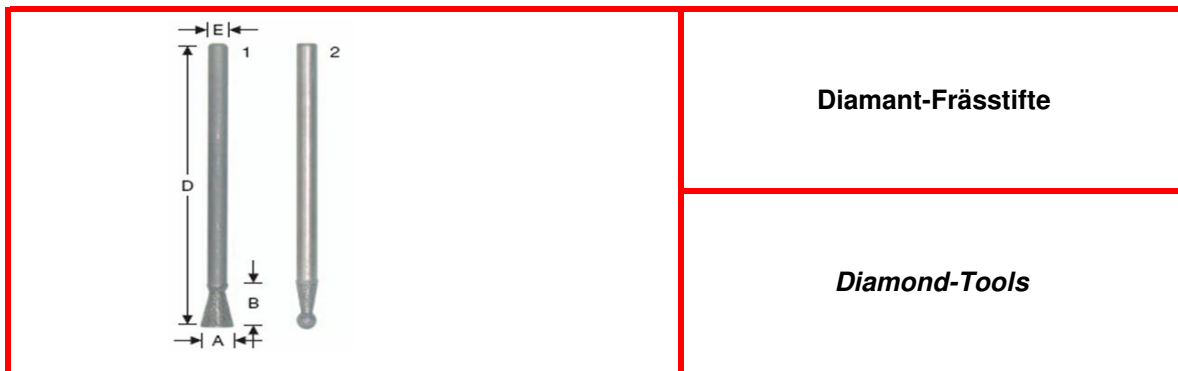

passend zu Druckluft-Dichtnutenfräse
für die Kunststoff-Fensterfertigung

*fits to pneumatic dentist drills
for the UPVC window production*

Artikel-Nr.	A	B	D	E	Abb.	Preis
6070	6,0 - 3,0	6	40	3	1	
6054	6,0 - 3,0	6	50	3	1	
6063	1,0	13	50	3	2	
6064	1,5	13	50	3	2	
6065	2,0	13	50	3	2	
6066	2,5	13	50	3	2	
2624	3,0	13	50	3	2	
6067	4,0	13	50	3	2	
6068	5,0	13	50	3	2	
6069	6,0	13	50	3	2	

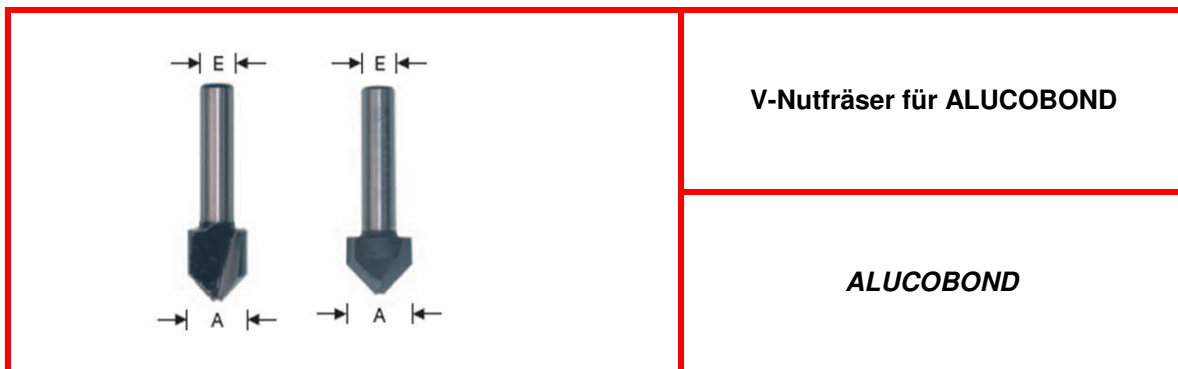

V-Nutfräser für Oberfräse / CNC-Fräse

*V-grooving bits for hand routers / CNC-machines
HM = Carbide tipped version*

Artikel-Nr.	A	B	E	Material	Preis
7953	16	90°	8	HM	
7954	18	135°	8	HM	
7955	14	90°	8	HSS	
7956	14	135°	8	HSS	

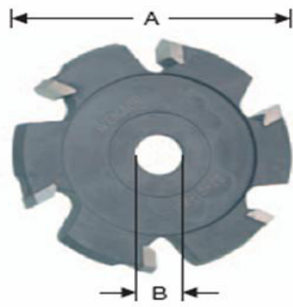

Scheibenfräser HM-bestückt für
ALUCOBOND

*Carbide tipped grooving cutters for
ALUCOBOND*

für Plattensägen und -fräsen

for sheet milling machines

Artikel-Nr.	A	B	C			Preis
7957	118	30	135°	Breite	18mm	
7958	220	30	90°	Breite	14mm	
7959	220	30	135°	Breite	18mm	
7961	244	30	135°	Breite	18mm	
7960	244	30	90°	Breite	14mm	



Fräsersätze für
Auslinkfräsmaschinen
Eckenputzmaschinen

*Grooving cutter sets for
end milling-machines
corner cleaning-machines*

nach Profilzeichnung / Muster

according profile drawing / sample

Ausklinkfräser HM-bestückt

Carbide tipped endmilling cutters

Einsetzbar in Maschinen von:

elumatec, Graule, Haffner, Pressta-Eisele, ...

for endmilling machines of:

elumatec, Graule, Haffner, Pressta-Eisele, ...

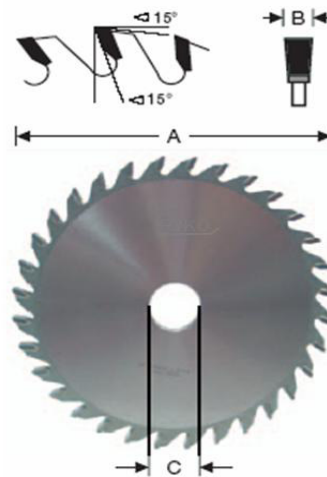

Artikel-Nr.	A	B	C	Z		Preis
7962	125	8,0	30	12		
7963	150	8,0	22	12		
7964	150	8,0	30	12		
7965	150	8,0	32	12		
7966	200	2,5	40	32		
7967	200	4,0	40	32		
7968	200	6,0	40	32		
7969	200	6,5	40	32		
7970	200	8,0	40	32		
7971	200	10,0	40	32		
7972	200	16,0	40	32		
7973	200	20,0	40	32		
7974	250	2,5	40	32		
7975	250	4,0	40	32		
7956	250	6,5	40	32		
7977	250	8,0	40	16		
7978	250	8,0	40	40		
7979	250	10,0	40	32		
7980	250	16,0	40	32		
7981	250	16,5	40	32		
7982	250	20,0	40	32		
7983	250	40,0	40	32		
7984	280	4,0	40	36		
7985	280	8,0	40	36		
7986	300	8,0	40	16		

Scheibenfräser HM-bestückt

Carbide tipped cutting disc

Zum Bearbeiten der Außenkontur auf
CNC-Verputzmaschinen:
URBAN, Stürtz, elumatec, Wegoma,

*Disc cutters for machining outer profile corners
used on CNC-corner cleaners as:
URBAN, Stürtz, elumatec, Wegoma,*

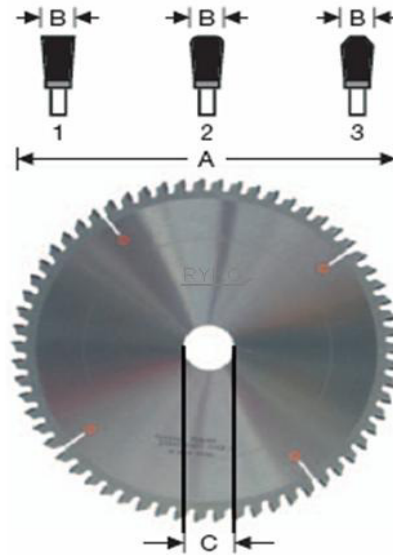

Artikel-Nr.	A	B	C	Z		Preis
7987	152	3,5	30	48	3	
7988	180	2,8	25	48	1	
7989	200	3,0	30	48	1	
7900	225	3,6	30	54	3	
7901	230	3,0	30	60	2	
7902	230	3,2	30	62	1	
7903	230	3,0	30	72	1	
7904	250	2,5	32	54	1	
7905	250	3,3	30	54	1	
7906	250	3,3	32	54	1	
7907	250	5,0	32	32	2	